

ADO-ADO, GENOMGÅNGSPLINT D1/5... .ADO

19956324
D1/5.ADO-ADO 0,22-1,0 mm (E2925800)

- 1 mm² / 13,5 A
- 5 mm bred
- Globala godkännanden

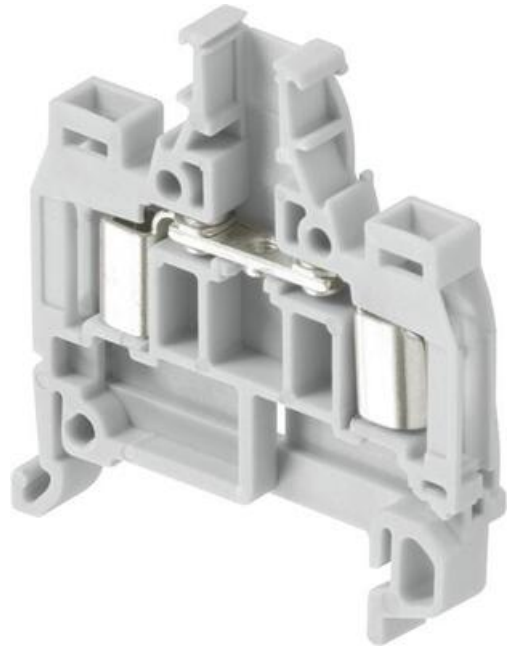

PRODUKTBESKRIVNING

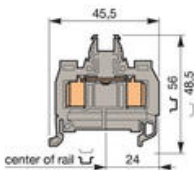

Standard 5 mm plint. Bredd 5 mm.

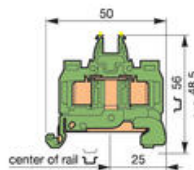

Plint för jordkabel. Bredd 5 mm.

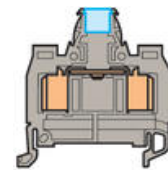

D1/5.ADO.1







ADO-kabel storlek 0,22-1 mm². Vid användande av fler kablar i samma klämma måste kablarna vara av samma area och utseende.

TEKNISK DATA

	IEC NFC VDE	UL	CSA
Anslutningsarea ADO entrådlig	0,2-1 mm ²	24-18	24-18
Anslutningsarea ADO flertrådlig	0,22-1 mm ²	24-18	24-18
Märkspänning V AC/DC	1 000	600	600
Märkström A	13,5	7	7
Nominell area	1 mm ²	18 AWG	18 AWG

BESTÄLLNINGSNUMMER

Beskrivning	Färg	Typ	Best.nr	E-nummer	Förp.stl.
ADO 0,22-1,0 mm ² , grå	■	D1/5. ADO	19956324	E2925800	50 st

ADO 0,22-1,0 mm ² , blå		D1,5.N.ADO	19956526	E2925801	50 st
ADO 0,22-1,0 mm ² , orange		D1/5.ADO	19956425		50 st
ADO 0,22-1,0 mm ² , svart		D1/5.ADO	19956627		50 st
ADO 0,22-1,0 mm ² , grön		D1/5.ADO	19957007		50 st
ADO 0,22-1,0 mm ² , röd		D1/5.ADO	19956720		50 st
ADO 0,22-1,0 mm ² , grå		D1/5.ADO.1	19934105		50 st
ADO 0,22-1,0 mm ² , jordplint med metallfot		D1/5.P.ADO	39903122	E2925825	50 st









TILLBEHÖR

Beskrivning	Anm	Best.nr	E-nummer	Förp.stl.
TS35 Skena, ohålad, 35x7,5x1 (2 m)		17430017		20x2 m
TS35F Skena, hålad, 35x7,5x1 (2 m)		17322005		20x2 m
TS35C Skena, hög, ohålad 35x15x1,5 (2 m)		16870022		10x2 m
TS35CF Skena, hög, hålad 35x15x1,5 (2 m)		TS35CF		10x2 m
BADL Ändstöd skruvlöst		39990302	E2925699	50 st
FEMAD3 Ändplatta, grå		19934105	E2925860	20 st
SCAD5 Skiljevägg, grå		19955120		20 st
AL2 Testhylsa 2 mm	(1)	16304624		10 st
FC2 Testplugg		786526	E2925658	10 st
BJM5 Överkoppling, 2-polig	(1)	17627301		10 st
BJM5 Överkoppling, 3-polig	(1)	17627402		10 st
BJM5 Överkoppling, 4-polig	(1)	17627503		10 st
BJM5 Överkoppling, 5-polig	(1)	17627604		10 st
BJM5 Överkoppling, 10-polig	(1)	17627705		10 st
BJS5 Överkopplingsskena, 20-polig (endast skena)	(1)	17765206		10 st
EV5 Skruv till BJS5-skena		16862916		100 st
BJA5 Överkoppling, 10-polig (korskoppling)		20502126	E2925725	10 st
CBM5 Skärmbleck		17874514		10 st
CBM8 Skärmbleck, 8 mm		17874615		10 st
OUMAD Handvektyg, ADO		17946606	E1647040	1 st
OUPAD Pistol för ADO plintar		17894404	E1647041	1 st
OUTA ADO pistolhuvud		20528403	E2925799	1 st

Märkning RC510

(1) Skiljevägg SCAD är nödvändig och 500 V (IEC) nominell spänning med detta tillbehör.



BADL	FEMAD3	BJA5
		
SCAD5	AL2	RC510
		
FC2	BJS5	OUMAD
		
BJM5	CBM	OUPAD

TEKNISK DATA

Anslutningsarea ADO entrådig IEC från	0,2 mm ²
Anslutningsarea ADO entrådig IEC till	1 mm ²
Anslutningsarea ADO flertrådig IEC från	0,22 mm ²
Anslutningsarea ADO flertrådig IEC till	1 mm ²
Antal anslutningar	2 st
Bredd	5 mm
Djup	45 mm
Färg	Grå
Förpackningsstorlek	50 st
Godkännanden	CE, CSA US, Gost R, RoHS
Höjd	48,5 mm
IP-klass	IP20
Material	Polyamid
Märkspänning CSA	600 V
Märkspänning IEC	1000 V
Märkström CSA	7 A
Märkström IEC	13,5 A
Nominell Area CSA	18 AWG
Nominell Area IEC	1 mm ²
Stötspänning	8000 V

